

# Round Fluted Aluminum Column

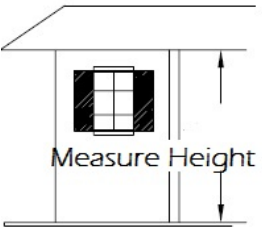
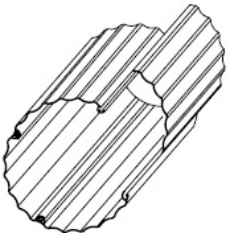
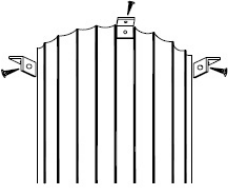
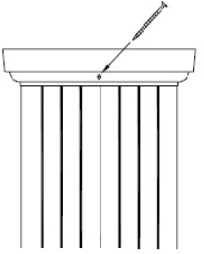

## INSTALLATION INSTRUCTIONS

<p>1. Measure the height of the opening where the column will be placed. Cut each column stave (piece) 1/4" longer than the opening. A circular saw with a metal cutting blade is recommended for cutting the staves.</p>	
<p>2. To assemble the column, hinge two staves together. Continue to add staves in this manner until only one remains. Slide remaining stave into each side of the partially assembled column, tap lightly with a rubber mallet if necessary.</p>	
<p>3. To install the capital and base, place the assembled column into the upright base. Slide the upright capital over the top of the column and all the way down to rest on the base. Do not secure. <i>Note: For decorative capitals, see installation instructions provided with the decorative capital.</i></p>	
<p>4. To secure the column, set the column (with the capital and base at the bottom) into place and plumb with a level. Raise the base and the capital and attach the column to the floor with the appropriate fasteners and screws. Repeat at the top of the column. <i>Note: High performance tie down brackets are available at an additional charge.</i></p>	
<p>5. To secure the capital, gently, slide the capital to the top of the column. Pre-drill holes and insert appropriate sized screws through the capital and the column wall. Allow the base to rest on the floor. It is not recommended to secure the base to the floor or to the column.</p>	
<p><b>Notes:</b></p> <ul style="list-style-type: none"><li>a. For best load-bearing performance, utilize AFCO load-bearing plates to spread the load over the entire perimeter of the column. Load-bearing capacity is dependent on distributing the load evenly over the surfaces of the shaft.</li><li>b. All column staves should be cut square and to the same length.</li><li>c. Installation should be on a smooth level surface.</li><li>d. 2nd story balconies should not be attached directly to the side of any column.</li><li>e. Columns should be installed according to standard construction practices and in compliance with applicable local, state, and federal regulations.</li></ul>	

ROUND FLUTED ALUMINUM COLUMN

# Round Fluted Wrap-Around Aluminum Column

## INSTALLATION INSTRUCTIONS



**AFCO**  
Columns and Railings  
a Division of AFCO Industries, Inc.

### SIZE CHART

COLUMN SIZE	STAVES PER COLUMN	MAXIMUM SIZE OF EXISTING ROUND POST	MAXIMUM SIZE OF EXISTING SQUARE POST
12	5	9 3/4"	7 1/2"
15	5	12"	9"
18	6	15"	11"
24	6	22 1/4"	15 1/2"

1. Measure the height of the opening where the column will be placed. Cut each column stave (piece) 1/4" longer than the opening. A circular saw with a metal cutting blade is recommended for cutting the staves.

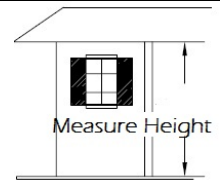

2. To assemble the column, hinge the smaller opening of the stave into the larger opening of the stave. Continue to add staves in this manner around the existing post until only one stave remains. Hinge the last modified stave to the partially assembled column and snap into place. Tap lightly with a rubber mallet if necessary to ensure the joint is fully engaged.

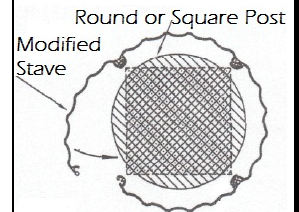

*Note: The stave with the modified lip has a portion of the inter-locking lip removed.*

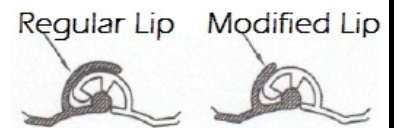

3. To secure the column, attach the column to the overhead beam or header with the appropriate fasteners and screws. Repeat this at the bottom of the column.  
*Note: High performance tie down brackets are available at an additional charge.*

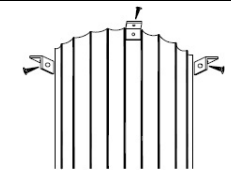

4. To assemble and install the capital and base, remove one screw from each side of the base. Place the two pieces of the base around the bottom of the column, flush with the floor and re-insert the screws to secure in place. Repeat this process with the capital at the top of the column. To secure the capital, gently slide the capital to the top of the column. Pre-drill holes and insert appropriate sized screws through the capital and the column wall. Be sure the capital is flush with both the header and the base. If needed, caulk between seams for a finished look. Allow the base to rest on the floor. It is not recommended to secure the base to the floor.  
*Note: For decorative capitals, see installation instructions provided with the decorative capital.*

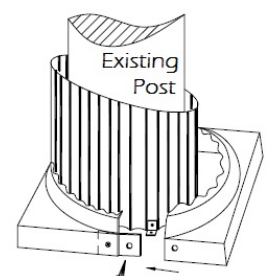

### Notes:

- This column is not load-bearing.
- All column staves should be cut square and to the same length.
- Installation should be on a smooth level surface.
- 2nd story balconies should not be attached directly to the side of any column.
- Columns should be installed according to standard construction practices and in compliance with applicable local, state, and federal regulations.

ROUND FLUTED WRAP-AROUND ALUMINUM COLUMN

# Round Fluted 6" & 8" Snap-Together Aluminum Column



## INSTALLATION INSTRUCTIONS

SIZE CHART			
COLUMN SIZE	STAVES PER COLUMN	MAXIMUM SIZE OF EXISTING ROUND POST	MAXIMUM SIZE OF EXISTING SQUARE POST
6	3	4 1/2"	3 1/2"
8	3	6 1/4"	4 1/2"

<p>1. Measure the height of the opening where the column will be placed. Cut each column stave (piece) 1/4" longer than the opening. A circular saw with a metal cutting blade is recommended for cutting the staves.</p>	
<p>2. To assemble the column, snap the interlocks of two staves together beginning at one end and continuing along the length of the column. Add staves in the same manner until column shaft is complete. Tap lightly with a rubber mallet if necessary. <u>For wrap-around-post installation:</u> Follow above instructions but add final stave with the partially assembled column in an upright position around the interior post.</p>	
<p>3. To secure the column, attach the column to the overhead beam or header with the appropriate fasteners and screws. Repeat this at the bottom of the column. <u>For whole capital and base:</u> Before putting the column into position, place the assembled column in the upright base. Slide the capital over the top of the column and all the way down to rest on the base. Then, set the column with the capital and base into place and plumb with a level. Secure the column. <i>Note: High performance tie down brackets are available at an additional charge.</i></p>	
<p>4. To assemble and install the split capital and base, place the two pieces of the base around the bottom of the secured column, flush with the floor and secure together with PVC glue. Repeat this process with the capital at the top of the column. Be sure the capital is flush with both the header and the base. <u>For whole capital and base:</u> To secure the capital to the top of the secured column, pre-drill holes and insert appropriate sized screws through the capital and the column wall. Installer may elect to use an optional installation method by securing the capital in place with construction adhesive. If needed, caulk between seams for a finished look. Allow the base to rest on the floor. It is not recommended to secure the whole base to the floor or to the column. <i>Note: For decorative capitals, see installation instructions provided with the decorative capital.</i></p>	

ROUND FLUTED 6" & 8" SNAP-TOGETHER ALUMINUM COLUMN

- Notes:**
- For best load-bearing performance, utilize AFCO load-bearing plates to spread the load over the entire perimeter of the column. Load-bearing capacity is dependent on distributing the load evenly over the surfaces of the shaft.
  - All column staves should be cut square and to the same length.
  - Installation should be on a smooth level surface.
  - 2nd story balconies should not be attached directly to the side of any column.
  - Columns should be installed according to standard construction practices and in compliance with applicable local, state, and federal regulations.

# Decorative Aluminum Capitals



**AFCO**  
Columns and Railings  
a Division of AFCO Industries, Inc.

## INSTALLATION INSTRUCTIONS

*Note: These instructions supplement the Round Fluted Aluminum Column Installation Instructions.*

1. Follow the appropriate installation instructions for measuring, cutting, assembly, and securing the column.

*Note: When measuring and cutting staves, allow for the additional height added by the decorative capital.*

2. Place the capital on floor, stand the assembled column in ring of capital. Using a 1/8" bit, drill holes in the column to align with the predrilled holes of the capital. Use the provided screws to secure the capital to the column.

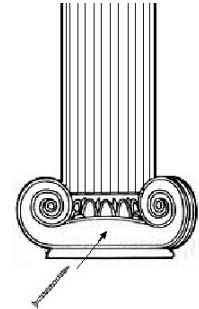

3. Place the assembled column on its side, then slide the base on the column shaft. Ensure the base aligns with the capital (do not secure).

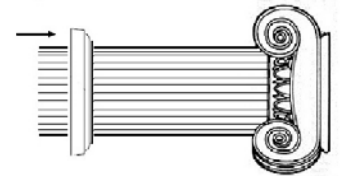

4. Set column in place and plumb with a level. Attach the capital to the upper structure by inserting the appropriate screws, thru pre-drilled holes in the ceiling end of the capital.

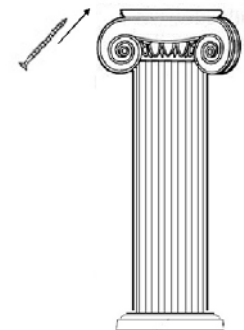

5. Caulk and paint as necessary to hide the seams and screw heads.

### Notes:

- For best load-bearing performance, utilize AFCO load-bearing plates to spread the load over the entire perimeter of the column. Load-bearing capacity is dependent on distributing the load evenly over the surfaces of the shaft.*
- All column staves should be cut square and to the same length.*
- Installation should be on a smooth level surface.*
- 2nd story balconies should not be attached directly to the side of any column.*
- Columns should be installed according to standard construction practices and in compliance with applicable local, state, and federal regulations.*

DECORATIVE ALUMINUM CAPITALS

# Decorative Split Aluminum Capitals



**AFCO**  
Columns and Railings  
a Division of AFCO Industries, Inc.

## INSTALLATION INSTRUCTIONS

*Note: These instructions supplement the Round Wrap-Around Aluminum Column Installation Instructions and the Round Fluted Snap-Together Aluminum Column Installation Instructions.*

1. Follow the appropriate installation instructions for measuring, cutting, assembly, and securing the column.  
*Note: When measuring and cutting staves, allow for the additional height added by the decorative capital.*

2. When preparing to install, ensure that the capital halves remain in pairs as received. Place one half of the split capital in place around the top of the column. Insert the appropriate screws, into the pre-drilled holes to attach the capital to the upper structure.

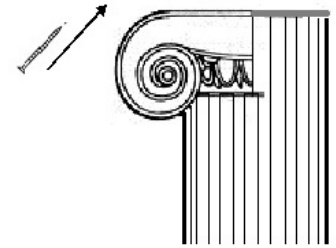

3. Repeat for the second half of the capital. Adjust as necessary to minimize any gaps at the seams.

4. Using a 1/8" bit, drill holes in the staves to align with the predrilled holes in the capital. Use the provided screws to secure the capital to the column.

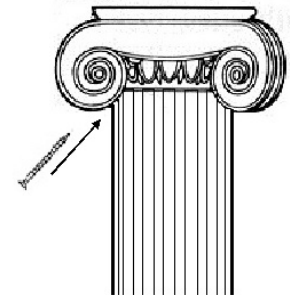

5. Caulk and paint as necessary to hide the seams and screw heads.

### Notes:

- For best load-bearing performance, utilize AFCO load-bearing plates to spread the load over the entire perimeter of the column. Load-bearing capacity is dependent on distributing the load evenly over the surfaces of the shaft.*
- All column staves should be cut square and to the same length.*
- Installation should be on a smooth level surface.*
- 2nd story balconies should not be attached directly to the side of any column.*
- Columns should be installed according to standard construction practices and in compliance with applicable local, state, and federal regulations.*

DECORATIVE SPLIT ALUMINUM CAPITAL

# Decorative Aluminum Capitals



## INSTALLATION INSTRUCTIONS

*Note: These instructions supplement the Round Fluted Aluminum Column Installation Instructions.*

1. Follow the appropriate installation instructions for measuring, cutting, assembly, and securing the column.

*Note: When measuring and cutting staves, allow for the additional height added by the decorative capital.*

2. Place the capital on floor, stand the assembled column in ring of capital. Using a 1/8" bit, drill holes in the column to align with the predrilled holes of the capital. Use the provided screws to secure the capital to the column.

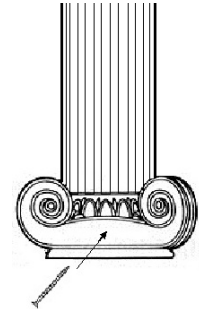

3. Place the assembled column on its side, then slide the base on the column shaft. Ensure the base aligns with the capital (do not secure).

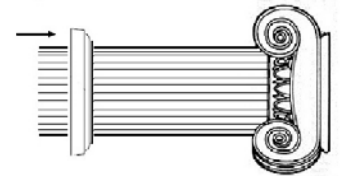

4. Set column in place and plumb with a level. Attach the capital to the upper structure by inserting the appropriate screws, thru pre-drilled holes in the ceiling end of the capital.

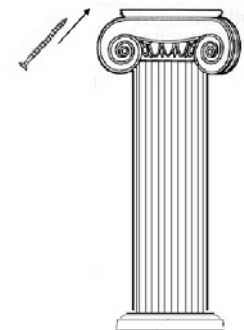

5. Caulk and paint as necessary to hide the seams and screw heads.

### Notes:

- For best load-bearing performance, utilize AFCO load-bearing plates to spread the load over the entire perimeter of the column. Load-bearing capacity is dependent on distributing the load evenly over the surfaces of the shaft.*
- All column staves should be cut square and to the same length.*
- Installation should be on a smooth level surface.*
- 2nd story balconies should not be attached directly to the side of any column.*
- Columns should be installed according to standard construction practices and in compliance with applicable local, state, and federal regulations.*



# Decorative Split Aluminum Capitals



**AFCO**  
Columns and Railings  
a Division of AFCO Industries, Inc.

## INSTALLATION INSTRUCTIONS

*Note: These instructions supplement the Round Wrap-Around Aluminum Column Installation Instructions and the Round Fluted Snap-Together Aluminum Column Installation Instructions.*

1. Follow the appropriate installation instructions for measuring, cutting, assembly, and securing the column.  
*Note: When measuring and cutting staves, allow for the additional height added by the decorative capital.*

2. When preparing to install, ensure that the capital halves remain in pairs as received. Place one half of the split capital in place around the top of the column. Insert the appropriate screws, into the pre-drilled holes to attach the capital to the upper structure.

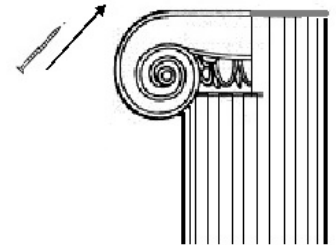

3. Repeat for the second half of the capital. Adjust as necessary to minimize any gaps at the seams.

4. Using a 1/8" bit, drill holes in the staves to align with the predrilled holes in the capital. Use the provided screws to secure the capital to the column.

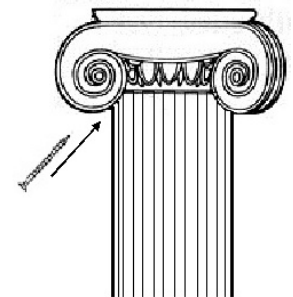

5. Caulk and paint as necessary to hide the seams and screw heads.

### Notes:

- For best load-bearing performance, utilize AFCO load-bearing plates to spread the load over the entire perimeter of the column. Load-bearing capacity is dependent on distributing the load evenly over the surfaces of the shaft.*
- All column staves should be cut square and to the same length.*
- Installation should be on a smooth level surface.*
- 2nd story balconies should not be attached directly to the side of any column.*
- Columns should be installed according to standard construction practices and in compliance with applicable local, state, and federal regulations.*



DECORATIVE SPLIT ALUMINUM CAPITAL

# Acadian, Craftsman, Empire & Square Fluted Aluminum Columns

## INSTALLATION INSTRUCTIONS FOR ALL SIZES

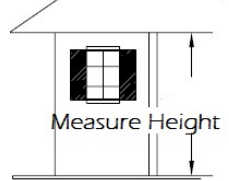

**AFCO**  
Columns and Railings  
a Division of AFCO Industries, Inc.

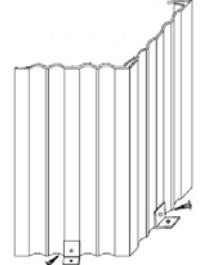
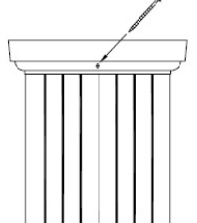
<p>1. Measure the height of the opening where the column will be placed. Cut each column stave (piece) 1/4" longer than the opening. A circular saw with a metal cutting blade is recommended for cutting the staves.</p>	
<p>2. To assemble the column, snap the interlocks of two staves together beginning at one end and continuing along the length of the column. Continue to add staves in this manner, until all staves are together. Tap lightly with a rubber mallet if necessary to ensure the joints are fully engaged.</p>	
<p><i>For 12" Square Fluted columns: 12" square column is supplied with eight (8) staves designed to mate together. Four (4) staves are designed to form the column corners and four (4) staves are designed to connect the corner pieces. Beginning at one end, snap the two staves together to create a corner piece. Repeat this process until each of the four (4) corners has been created. Next, snap two corner pieces together. Continue to add staves in this manner, until all staves are together. Tap lightly with a rubber mallet if necessary to ensure the joints are fully engaged.</i></p>	 <p>2nd Step for 12" Column</p>
<p>3. To install the capital and base, place the assembled column in the upright base. Slide the upright capital over the top of the column and all the way down to rest on the base. Do not secure.</p>	
<p>4. To place and secure the column, set the column (with the capital and base at the bottom) into place and plumb with a level. Raise the base and the capital and attach the column to the floor with the appropriate fasteners and screws. Repeat at the top of the column. <i>Note: High performance tie down brackets are available at an additional charge.</i></p>	
<p>5. To secure the capital, gently, slide the capital to the top of the column. Pre-drill holes and insert appropriate sized screws through the capital and the column wall. Allow the base to rest on the floor. It is not recommended to secure the base to the floor or to the column.</p>	
<p><b>Notes:</b></p> <ol style="list-style-type: none"> <li>For best load-bearing performance, utilize AFCO load-bearing plates to spread the load over the entire perimeter of the column. Load-bearing capacity is dependent on distributing the load evenly over the surfaces of the shaft.</li> <li>All column staves should be cut square and to the same length.</li> <li>Installation should be on a smooth level surface.</li> <li>2nd story balconies should not be attached directly to the side of any column.</li> <li>Columns should be installed according to standard construction practices and in compliance with applicable local, state, and federal regulations.</li> </ol>	

ACADIAN, CRAFTSMAN, EMPIRE & SQUARE FLUTED ALUMINUM COLUMNS



# Acadian Wrap-Around Aluminum Column



**AFCO**  
Columns and Railings  
a Division of AFCO Industries, Inc.

## INSTALLATION INSTRUCTIONS

SIZE CHART			
COLUMN SIZE	STAVES PER COLUMN	MAXIMUM SIZE OF EXISTING ROUND POST	MAXIMUM SIZE OF EXISTING SQUARE POST
6	4	4- 1/2"	4- 1/2" X 4- 1/2"
8	4	5- 3/4"	5- 3/4" X 5- 3/4"

1. Measure the height of the opening where the column will be placed. Cut each column stave (piece) 1/4" longer than the opening. A circular saw with a metal cutting blade is recommended for cutting the staves.

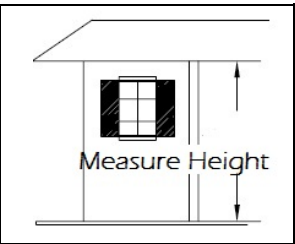

2. To assemble the column, snap the interlocks of two staves together beginning at one end and continuing along the length of the column. This will form half of the column. Repeat this process with two more staves to form the other half of the column. Tap lightly with a rubber mallet if necessary to insure the joint is fully engaged.

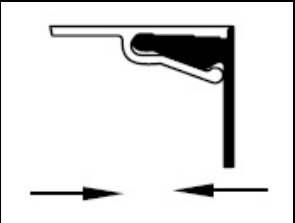

3. To install the capital and base, place each half of the base onto half of the column. Place each half of the capital onto half of the column. Snap the two halves of the column with the base and capital together. For wrap around post installation, assemble the column in an upright position around interior post. Tap lightly with a rubber mallet if necessary to ensure the joints are fully engaged.

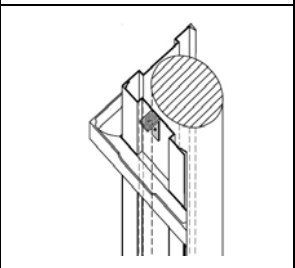

4. To secure the column, gently slide the capital away from the top of the column. Attach the column to the overhead beam or header with the provided fasteners and screws. Repeat this at the bottom by gently sliding the base up and securing the column to the floor.  
*Note: High performance tie down brackets are available at an additional charge.*

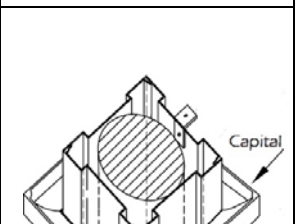

5. To secure the capital, gently, slide the capital to the top of the column. Pre-drill holes and insert appropriate sized screws through the capital and the column wall. Allow the base to rest on the floor. It is not recommended to secure the base to the floor or to the column. If needed, caulk between seams for a finished look.



*Note: An optional decorative block kit is available for the Acadian Wrap-Around Aluminum Column. See installation in-*

- Notes:**
- a. For best load-bearing performance, utilize AFCO load-bearing plates to spread the load over the entire perimeter of the column. Load-bearing capacity is dependent on distributing the load evenly over the surfaces of the shaft.
  - b. All column staves should be cut square and to the same length.
  - c. Installation should be on a smooth level surface.
  - d. 2nd story balconies should not be attached directly to the side of any column.
  - e. Columns should be installed according to standard construction practices and in compliance with applicable local, state, and federal regulations.

ACADIAN WRAP-AROUND ALUMINUM COLUMN

# 6" Craftsman Column - Assembly & Installations

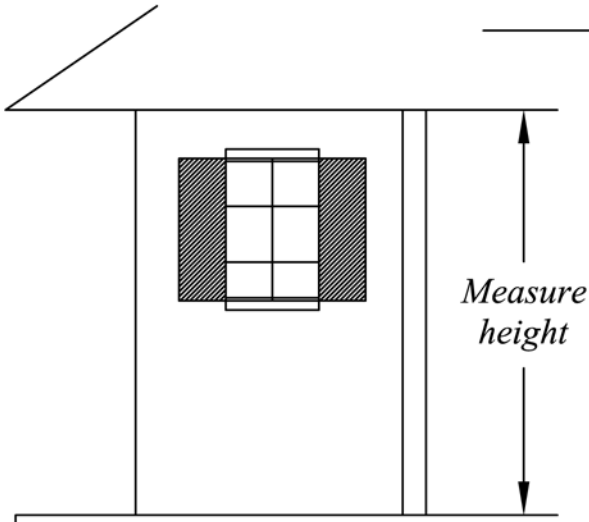

**STEP 1.** Measure height of opening and cut column staves with hack saw  $\frac{1}{4}$ " longer than opening.

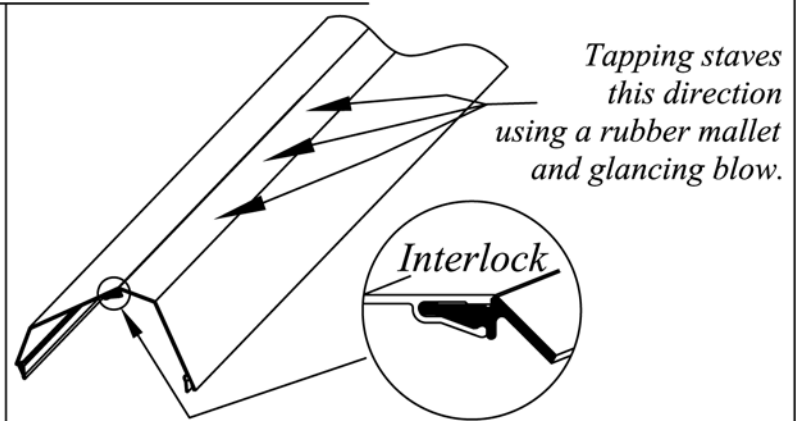

**STEP 2.** Lay (2) staves on the solid surface and assemble by snapping interlocks together at corners using rubber mallet in the direction as shown. Continue process with remaining staves.

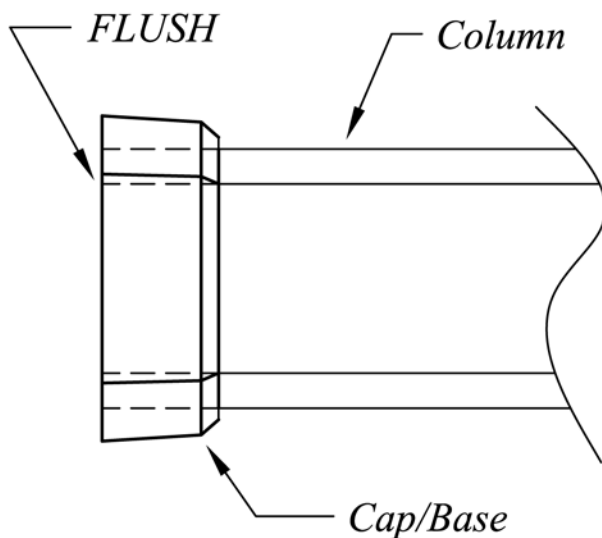

**STEP 3.** Slide cap and base onto each end of column. Column must extend thru cap and base for proper installation. Slide cap/base up or down to fit FLUSH with header or floor.

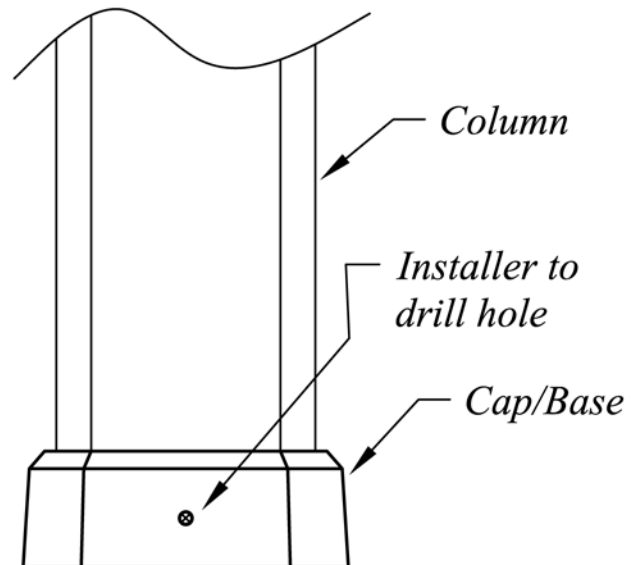

**STEP 4.** Secure cap and base with screws provided.

Note: Load-bearing capacity is dependent on distributing the load evenly over bearing surfaces of the shaft. All installation information is of a general nature; columns should be installed and secured (fastened) according to standard construction practices and in compliance with applicable local, state and federal building regulations.

# Square Wrap-Around Aluminum Column



## INSTALLATION INSTRUCTIONS

SIZE CHART			
COLUMN SIZE	STAVES PER COLUMN	MAXIMUM SIZE OF EXISTING ROUND POST	MAXIMUM SIZE OF EXISTING SQUARE POST
4	2	3"	3"
6	4	4 7/8"	4 1/2"
8	4	6 7/8"	6 1/2"
10	4	8 1/2"	8 1/2"
12	8	10"	10"

<p>1. Measure the height of the opening where the column will be placed. Cut each column stave (piece) 1/4" longer than the opening. A circular saw with a metal cutting blade is recommended for cutting the staves.</p>	<p>Measure Height</p>
<p>2. To assemble the column, snap the interlocks of two staves together beginning at one end and continuing along the length of the column. Continue to add staves in this manner, until all staves are together. Tap lightly with a rubber mallet if necessary to ensure the joints are fully engaged. For wrap-around-post installation follow above instructions but add final stave with the partially assembled column in an upright position around the interior post.</p>	
<p>3. To secure the column, attach the column to the overhead beam or header with the appropriate fasteners and screws. Repeat this at the bottom of the column. <i>Note: High performance tie down brackets are available at an additional charge.</i></p>	
<p>4. To assemble and install the capital and base, place the two pieces of the base around the bottom of the column, flush with the floor and insert the provided screws to secure in place. Repeat this process with the capital at the top of the column. Be sure the capital is flush with both the header and the base. If needed, caulk between seams for a finished look.</p>	

SQUARE WRAP-AROUND ALUMINUM COLUMN

- Notes:*
- a. For best load-bearing performance, utilize AFCO load-bearing plates to spread the load over the entire perimeter of the column. Load-bearing capacity is dependent on distributing the load evenly over the surfaces of the shaft.
  - b. All column staves should be cut square and to the same length.
  - c. Installation should be on a smooth level surface.
  - d. 2nd story balconies should not be attached directly to the side of any column.
  - e. Columns should be installed according to standard construction practices and in compliance with applicable local, state, and federal regulations.

# Wellington Aluminum Column



**AFCO**  
Columns and Railings  
a Division of AFCO Industries, Inc.

## INSTALLATION INSTRUCTIONS

1. Measure the height of the opening where the column will be placed. Cut each column stave (piece) 1/4" longer than the opening. A circular saw with a metal cutting blade is recommended for cutting the staves.

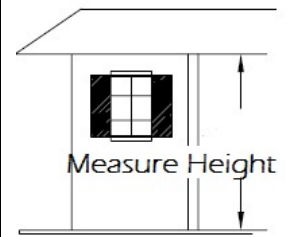

2. To assemble the column, snap the interlocks of two staves together beginning at one end and continuing along the length of the column. Continue to add staves in this manner, until all staves are together. Tap lightly with a rubber mallet if necessary to ensure the joints are fully engaged.

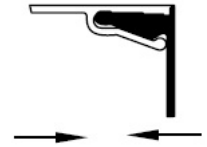

3. To install the capital, base, and astragal (if required) place the assembled column in the upright base. Slide the astragal over the top of the column and all the way down to rest on the base. Repeat with the capital. Do not secure.

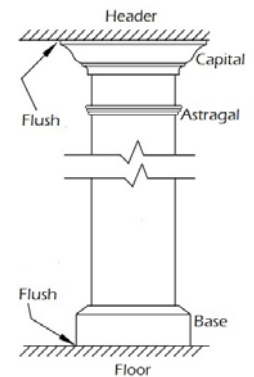

4. To place and secure the column, set the column (with the capital base, and astragal at the bottom) into place and plumb with a level. Raise the base and the capital and attach the column to the floor with the appropriate fasteners and screws. Repeat at the top of the column.

*Note: High performance tie down brackets are available at an additional charge.*

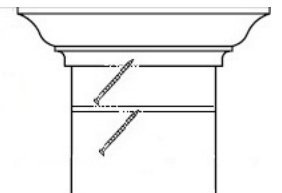

5. To secure the capital and astragal, gently, slide the capital to the top of the column. Pre-drill holes and insert appropriate sized screws through the capital and the column wall. Repeat with the astragal, positioning at the height desired (usually 12" - 18" below capital). Allow the base to rest on the floor. It is not recommended to secure the base to the floor or to the column.

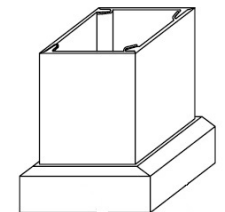

### Notes:

- For best load-bearing performance, utilize AFCO load-bearing plates to spread the load over the entire perimeter of the column. Load-bearing capacity is dependent on distributing the load evenly over the surfaces of the shaft.*
- All column staves should be cut square and to the same length.*
- Installation should be on a smooth level surface.*
- 2nd story balconies should not be attached directly to the side of any column.*
- Columns should be installed according to standard construction practices and in compliance with applicable local, state, and federal regulations.*

# Wellington Wrap-Around Aluminum Column



**AFCO**  
Columns and Railings  
a Division of AFCO Industries, Inc.

## INSTALLATION INSTRUCTIONS

<p>1. Measure the height of the opening where the column will be placed. Cut each column stave (piece) 1/4" longer than the opening. A circular saw with a metal cutting blade is recommended for cutting the staves.</p>	
<p>2. To assemble the column, snap the interlocks of two staves together beginning at one end and continuing along the length of the column. Continue to add staves in this manner. Snap the final stave into place and tap lightly with a rubber mallet if necessary to ensure the joint is fully engaged. For wrap-around-post installation follow above instructions but add final stave with the partially assembled column in an upright position around the interior post.</p>	
<p>3. To secure the column, attach the column to the overhead beam or header with the appropriate fasteners and screws. Repeat this at the bottom of the column. <i>Note: High performance tie down brackets are available at an additional charge.</i></p>	
<p>4. To assemble and install the capital and base, drill and counter-sink through flat surface of both halves of the base with 1/8" bit. Install both halves to the bottom of the column, flush with the floor, and secure them with the provided screws on all sides. Repeat this process with the capital at the top of the column. If needed, caulk between seams for a finished look.</p> <p><u>To assemble and install the astragal</u>, drill and counter-sink through flat surface of both halves of astragal with 1/8" bit. Position at height desired (usually about 12" – 18" below capital). Then attach both halves to the column, and secure them with the provided screws on all sides. If needed, caulk between seams for a finished look.</p>	
<p><b>Notes:</b></p> <ol style="list-style-type: none"> <li>For best load-bearing performance, utilize AFCO load-bearing plates to spread the load over the entire perimeter of the column. Load-bearing capacity is dependent on distributing the load evenly over the surfaces of the shaft.</li> <li>All column staves should be cut square and to the same length.</li> <li>Installation should be on a smooth level surface.</li> <li>2nd story balconies should not be attached directly to the side of any column.</li> <li>Columns should be installed according to standard construction practices and in compliance with applicable local, state, and federal regulations.</li> </ol>	

WELLINGTON WRAP-AROUND ALUMINUM COLUMN